





















FL SOLNAR SLR

Solární LED svítidlo

IP
54

EA
SY
instal
ation

 3,7 DC	 15000	 20000	 ellipse ≤ 6x MacAdam	 Ra 80	 SMD	
 III		 -15÷35		 max 10	 120	 10-1
 15-1000	 max 100					



FL SOLNAR SLR 8W NW-B



IP



FL SOLNAR SLR 8W NW-B **36605** max 8 max 800 4000 54 PIR

Svítidlo Kanlux FL SOLNAR je reflektor napájený sluneční energií. Výkon reflektoru je 8 W a jeho světelná účinnost je 100lm/W (když je svítidlo plně nabitě). IP54 umožňuje bez obav instalovat reflektor do zvýšené prašnosti a vlhkosti a také do míst, která nejsou zastřešená. Nastavitelný adaptér umožňuje namontovat svítidlo a solární panel samostatně. Reflektor je vybaven senzorem pohybu.

- Svítidlo je dodáváno včetně 2m prodlužovacího kabelu, který umožňuje instalaci fotovoltaického panelu v určité vzdálenosti od svítidla.
- Materiál korpusu: PC
- Materiál difuzoru: PC

FL SOLNAR SLR

Solární LED svítidlo





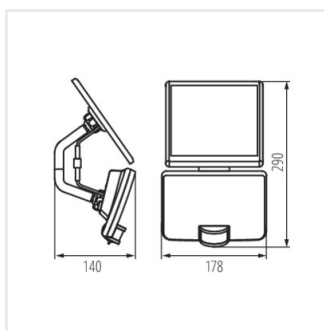

FL SOLNAR SLR 8W NW-B

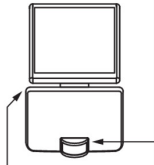

FL SOLNAR SLR 8W NW-B

FL SOLNAR SLR

Solární LED svítidlo

	 15lx - 1000lx	
 1 MODE	—	max 800 lm ⌚ 10s - 60s
 2 MODE Night light	~40 lm	max 800 lm ⌚ 10s - 60s